

Common Choke HEMC753 Series

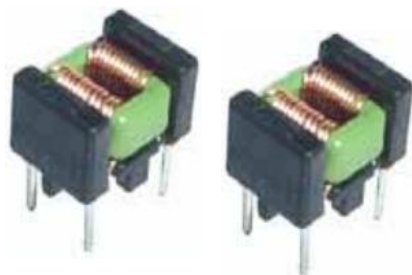

Features

- Compact size high performance and low cost.
- Large impedance at high frequencies.
- Excellent high frequency characteristics.

Application

- Applied equipment: TV , VCR, Switching power NC machines, Computes systems and Measuring instruments.

Configurations & Dimensions

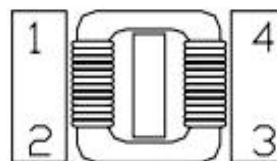
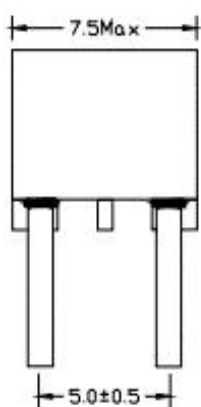
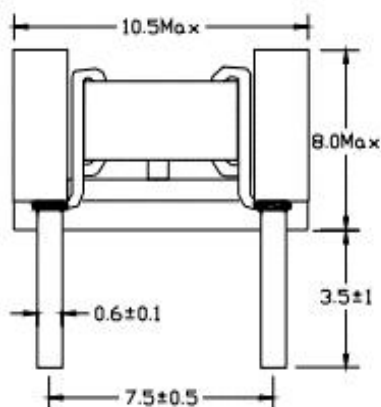

CIRCUIT:

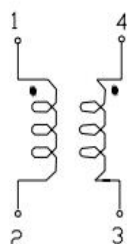

TEST CIRCUIT:

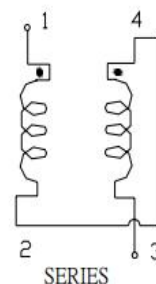
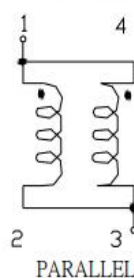

Specifcatons HEMC753

Part Number	Inductance (uH) @1KHz	Impedance (Ω) Min	DC Resistance (mΩ) max
HEMC753-170	17 ± 20%	390@300MHz	25
HEMC753-270	27 ± 50%	900@50MHz	30

Common Choke HEMC753 Series



Impedance & Frequency

PARALLEL



SERIES

